

Backwall 2.4m Formulate Straight

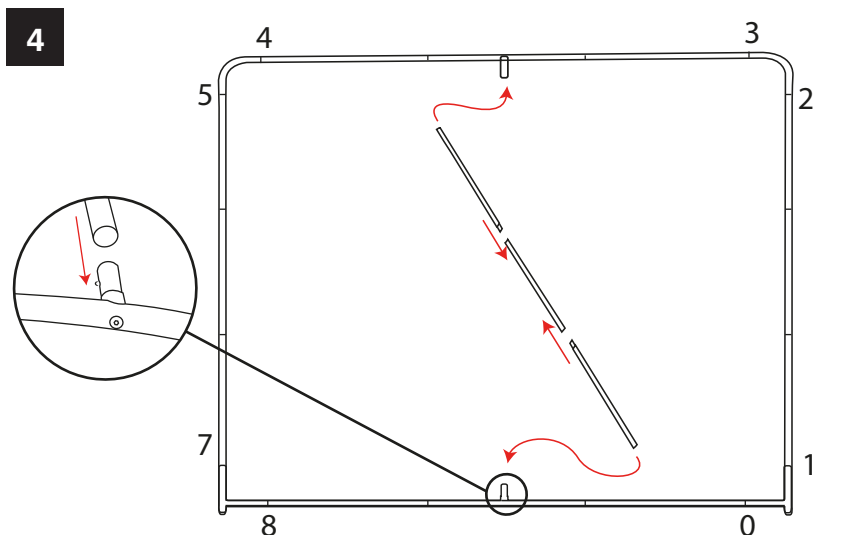

Backwall
2.4m Formulate Straight

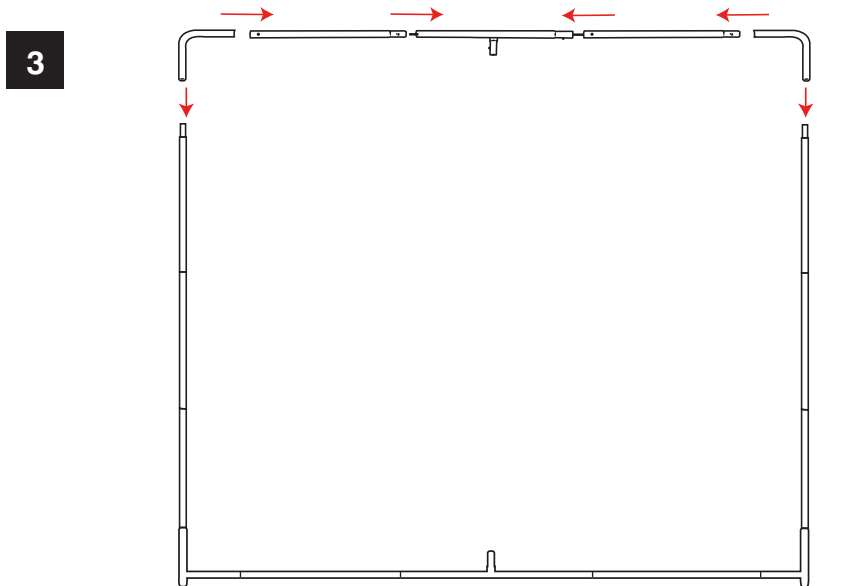
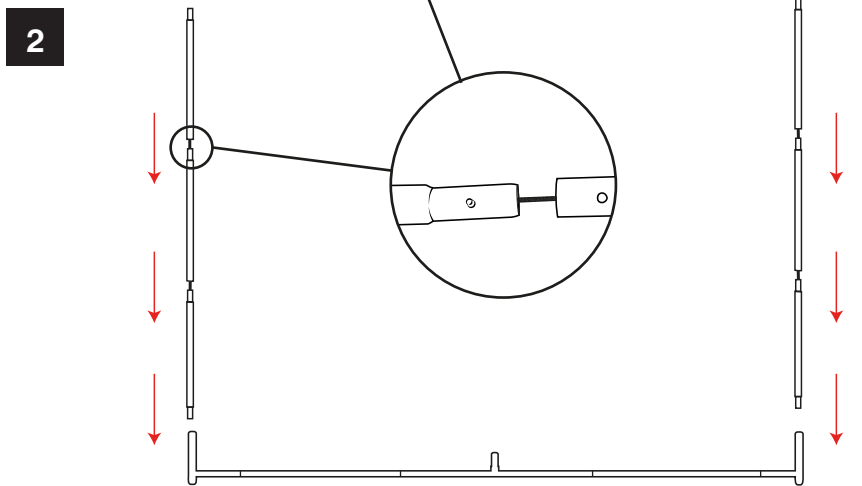
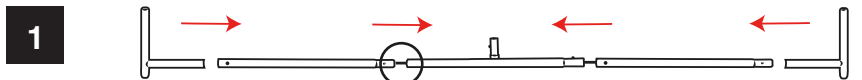
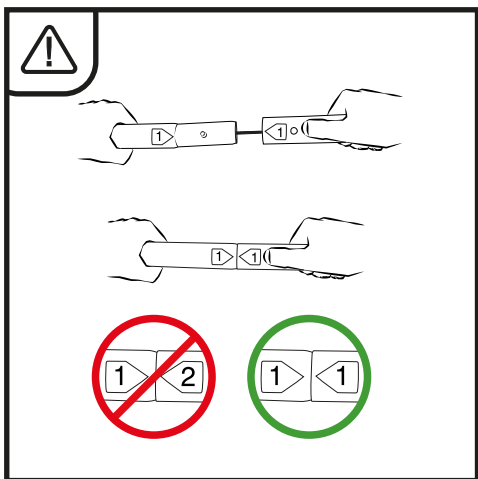
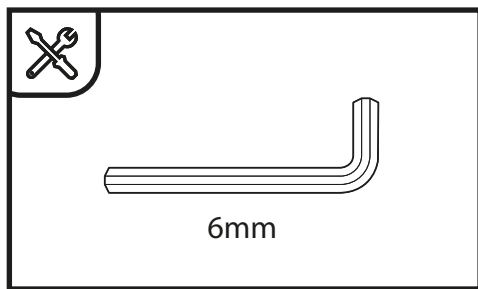
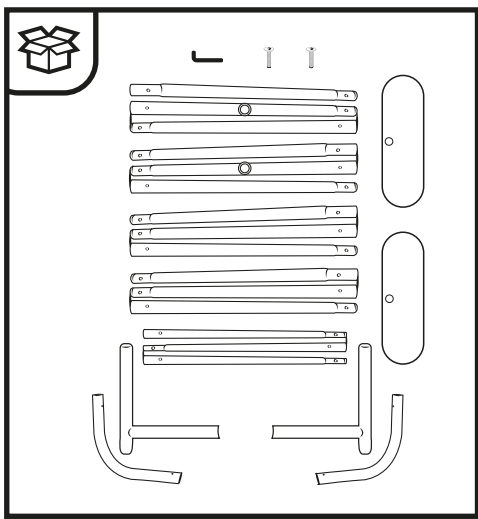

5

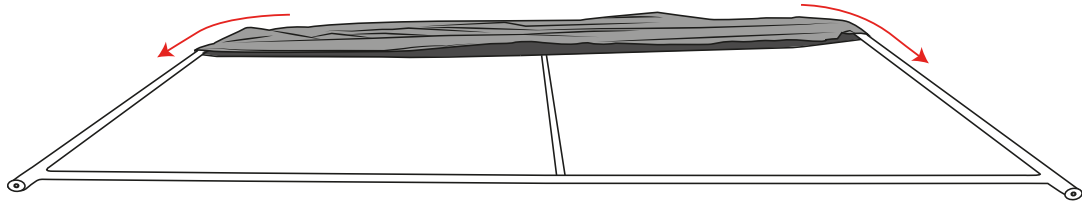

6

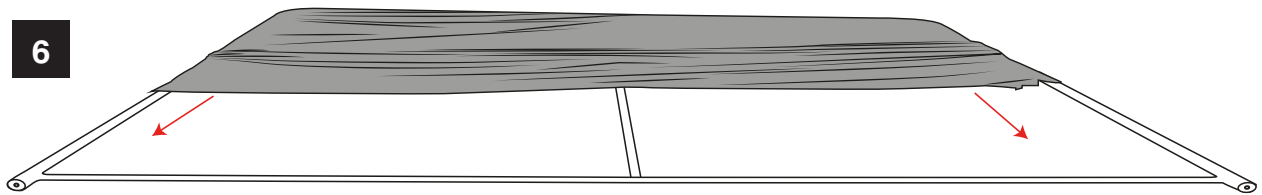

7

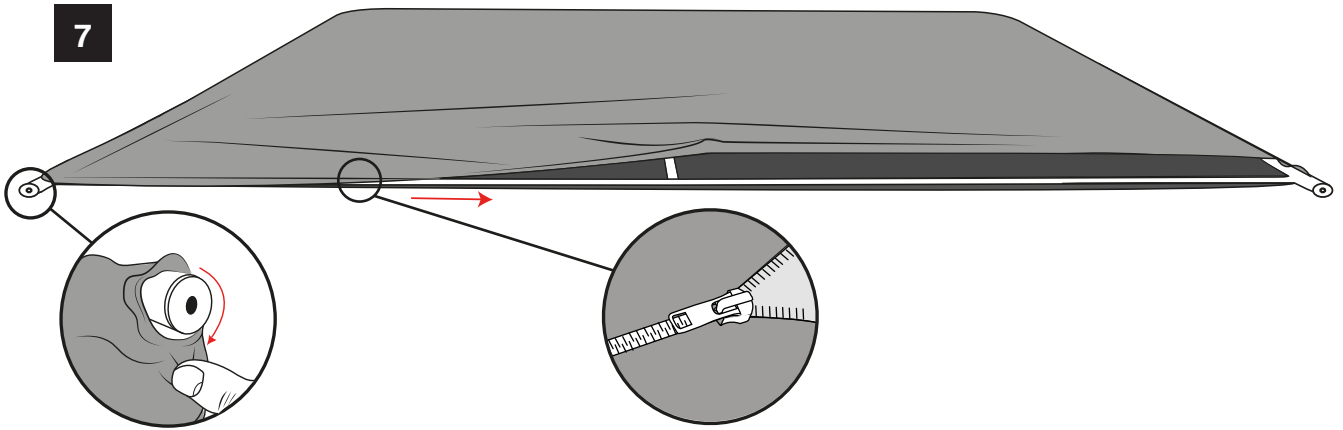

8

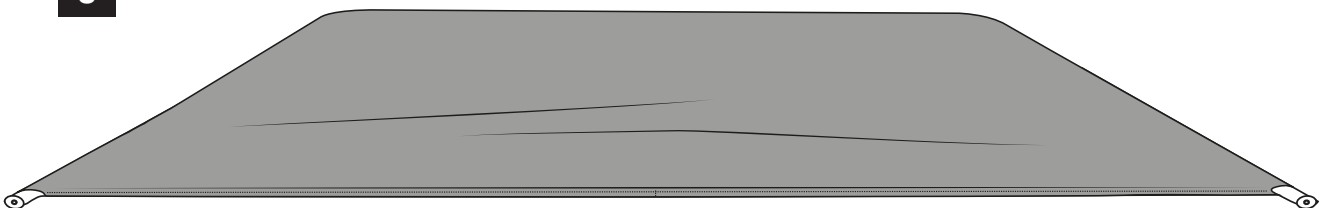



9

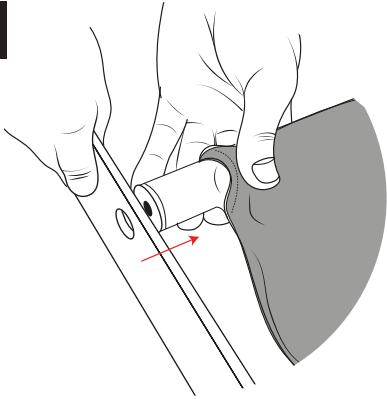

10

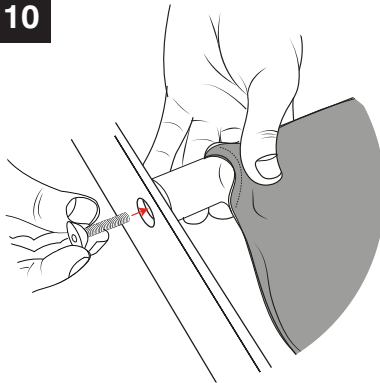

11

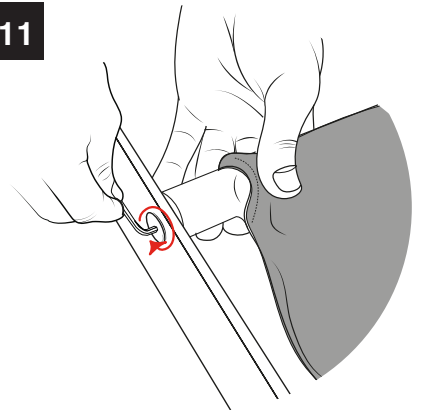

12

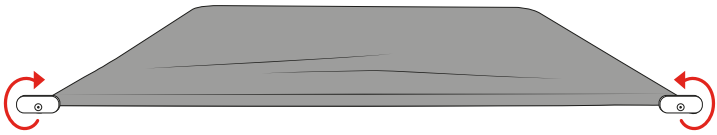

13

